



# QDV

## Models 8420, 8428, 8430, 8438, 8440, 8441 Units with Bottle and/or Button activation

### Package Should Contain:

1. Proportioner unit.
2. Chemical inlet tubing.
3. In-line check valves, foot strainers, & weights.
4. Discharge tubes for eductors.
5. Metering tip kit.
6. Mounting anchor kit.
7. Instruction sheet.

### THANK YOU FOR YOUR INTEREST IN OUR PRODUCTS

Please use this equipment carefully and observe all warnings and cautions.

\*\*\*\*\*NOTE\*\*\*\*\*

#### WEAR

protective clothing and eyewear when dispensing chemicals or other materials or when working in the vicinity of all chemicals, filling or emptying equipment, or changing metering tips.

#### ALWAYS

observe safety and handling instructions of the chemical manufacturer.

direct discharge away from you or other persons or into approved containers.

dispense cleaners and chemicals in accordance with manufacturer's instructions. Exercise **CAUTION** when maintaining your equipment.

reassemble equipment according to instruction procedures. Be sure all components are firmly screwed or latched into position.

#### KEEP

equipment clean to maintain proper operation.

### Installation and Operation:

1. Remove select knob by pulling straight off.

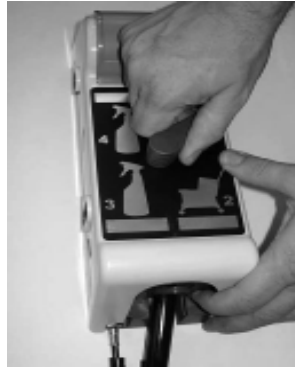

2. Remove dispenser cover by depressing tabs on each side.

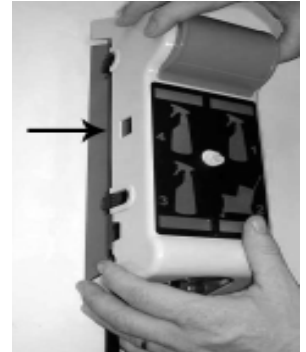

3. Use the cabinet back as a template to mark the proper spacing of the (3) mounting screw holes.

4. Drill holes for (3) wall anchors with a 9/32" drill bit, install mounting anchors, and then screws in top (2) anchors.

5. Slide key holes in cabinet back over screw heads, tighten screws, then install bottom screw.



6. a) Install high flow (3.3 GPM) discharge tube.
- b) Install low flow (1.0 GPM) discharge tube.

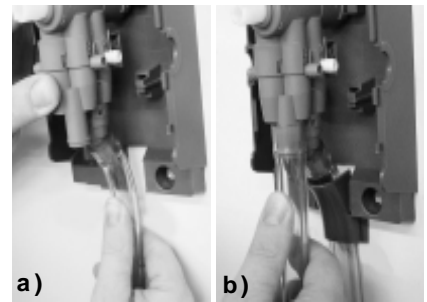

7. Connect water supply hose of at least 1/2" ID to water inlet swivel. (minimum 25 PSI pressure, with water running, is required for proper operation.)

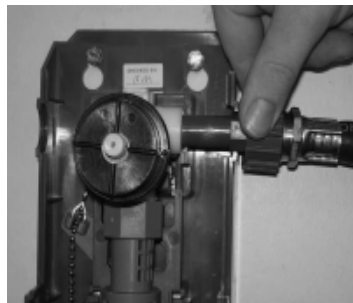

8. For Button activated units: Models 8420, 8428, 8430, 8438, 8440. Buttons can be made locking by removing the tabs in the cover on each side of the button track.

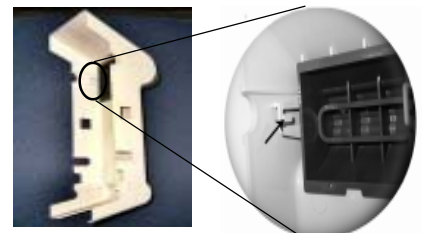

(Installation/Operation instructions cont'd.)

9. Select desired metering tips for product concentrate inlets.

Grey inlet barb = 1.0 GPM, Yellow inlet barb = 3.5 GPM.

Push each tip firmly into hose barb. Refer to tip selection guide (page 4). Refer to Product Selection Diagram (below) to insure each tip is inserted into the proper hose barb. **Note: A CLEAR TIP IS PROVIDED AND MUST BE INSTALLED IN ANY UNUSED INLET BARB FOR UNIT TO FUNCTION PROPERLY.**

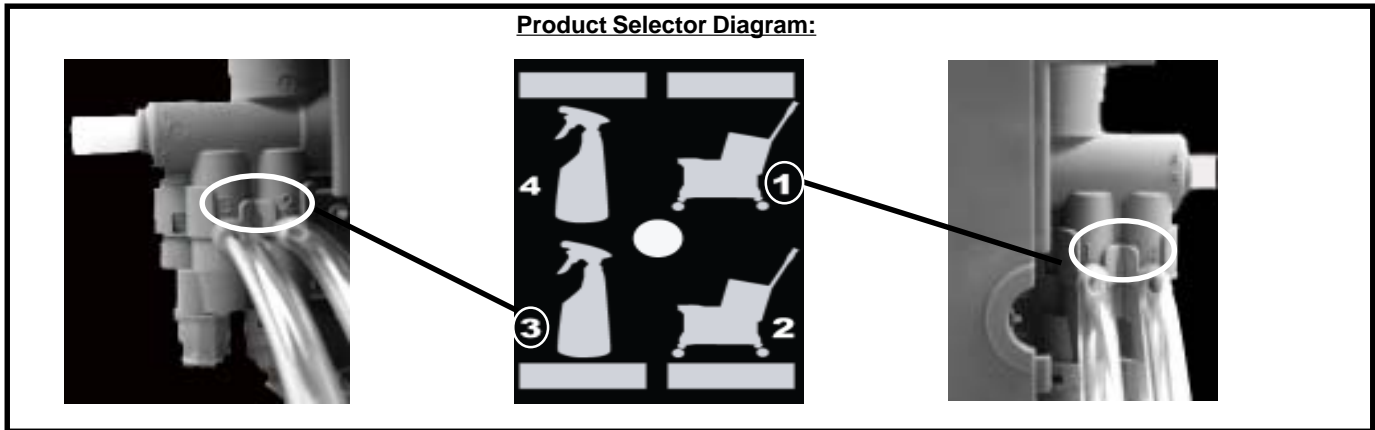

10. Install chemical inlet tubing. Install 5.5" piece of tubing (a) on inlet barb. Install in-line check valve (b) with arrow pointing away from the chemical container. Cut a piece of tubing (c) for each product long enough to run from the inlet barb to the bottom of the chemical container. Slide ceramic weight (d) over one end of tube and insert foot strainer (e) into the same end of the tube. **NOTE: REMEMBER TO CHECK STRAINERS PERIODICALLY FOR CLOGGING: CLEAN IF NECESSARY.**

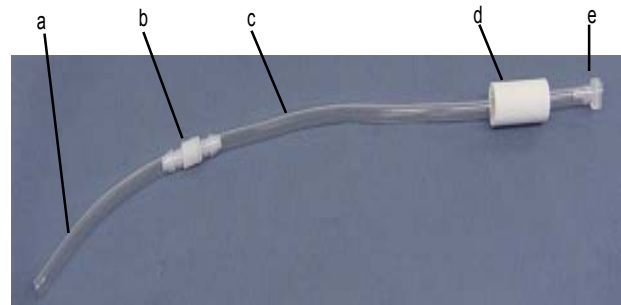

11. Reinstall cover and select knob.



12. Turn on water supply. Purge air from system by briefly depressing the flow activating devices.

13. For bottle activated units, insert a spray bottle over the short discharge tube and lift lever to start flow. To stop flow, lower bottle from dispenser.



**QDV Parts Diagram/List:**

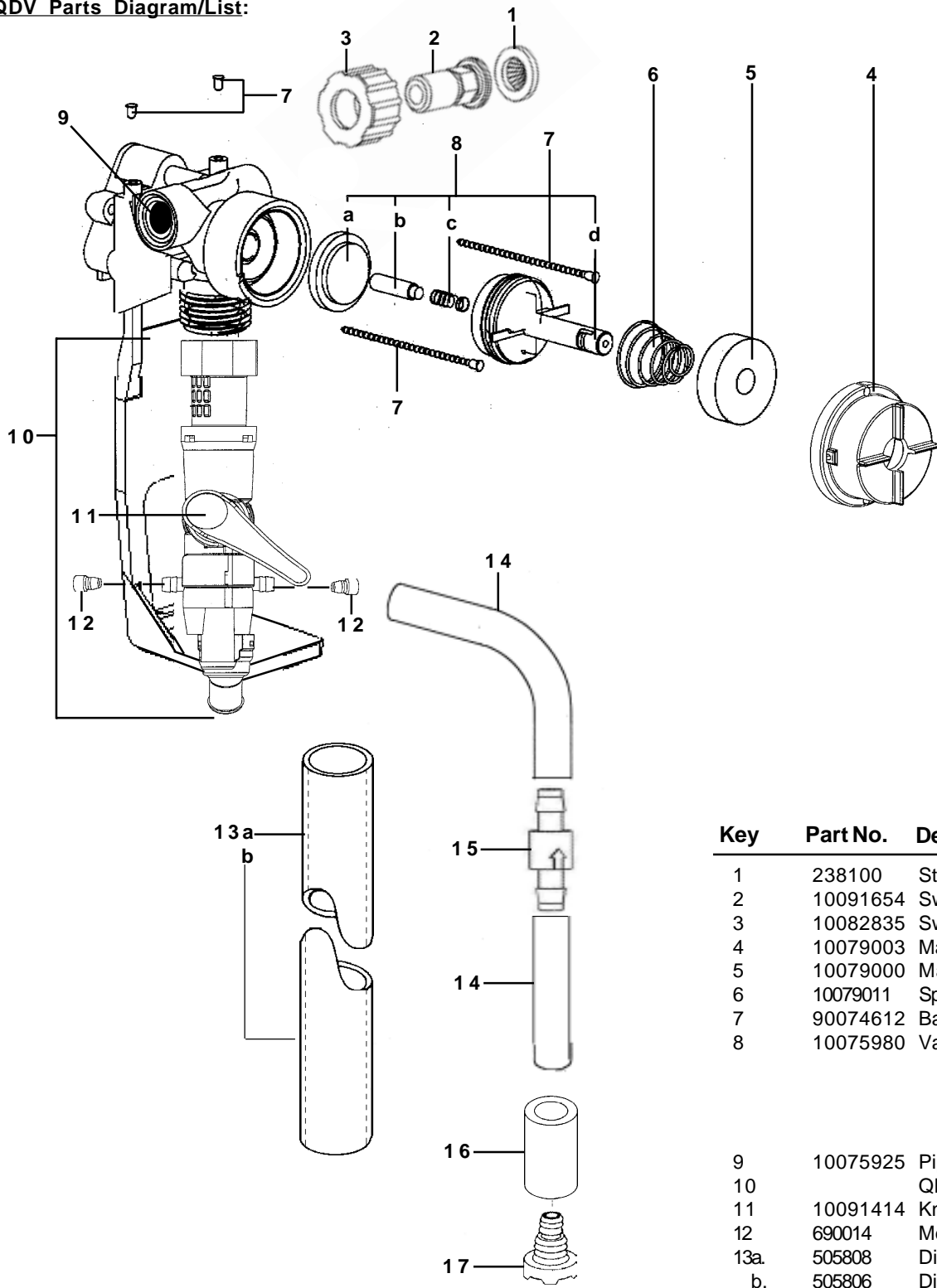

| Key  | Part No. | Description  |
|------|----------|--|
| 1    | 238100   | Strainer washer  |
| 2    | 10091654 | Swivel stem (molded)   |
| 3    | 10082835 | Swivel collar (molded)   |
| 4    | 10079003 | Magnet cover w/chain slot  |
| 5    | 10079000 | Magnet   |
| 6    | 10079011 | Spring   |
| 7    | 90074612 | Ball chain w/sleeve  |
| 8    | 10075980 | Valve parts kit<br>a. diaphragm<br>b. armature<br>c. spring<br>d. valve bonnet |
| 9    | 10075925 | Pipe plug, 3/8"  |
| 10   |          | QDV assy   |
| 11   | 10091414 | Knob assy, QDV   |
| 12   | 690014   | Metering tip kit   |
| 13a. | 505808   | Discharge tube, 1/2"x8" (1 GPM)  |
| b.   | 505806   | Discharge tube, 1/2"x6' (3.3 GPM)  |
| 14   | 500821   | Tubing 1/4" x21'   |
| 15   | 90083033 | In-line check valve, EPDM  |
| 16   | 509900   | Weight   |
| 17   | 609600   | Foot strainer  |

Not shown:  
10091415 Bottle pusher extension

**Metering Tip Selection:**

The final concentration of the dispensed solution is related to both, the size of the metering tip opening, and the viscosity of the liquid being siphoned. For water-thin products, the chart can be used as a guideline. Because dilution can vary with water temperature and pressure, and if the product is noticeably thicker than water, dilution rates shown should be viewed as approximates.

| APPROXIMATE DILUTIONS AT 40 PSI FOR WATER-THIN PRODUCTS (1.0 CP) |              |                   |                       |         |           |              |                   |                       |         |
|--|--------------|-------------------|-----------------------|---------|-----------|--------------|-------------------|-----------------------|---------|
| Tip Color  | Orifice Size | Std. Drill Number | Ratio(perEductorFlow) |         | Tip Color | Orifice Size | Std. Drill Number | Ratio(perEductorFlow) |         |
|  |              |                   | 1.0 GPM               | 3.5 GPM |           |              |                   | 1.0 GPM               | 3.5 GPM |
| No Tip   | .187         | (3/16)            | 3:1                   | 3.5:1   | Green     | .028         | (70)              | 16:1                  | 45:1    |
| Grey   | .128         | (30)              | 3:1                   | 4:1     | Orange    | .025         | (72)              | 20:1                  | 56:1    |
| Black  | .098         | (40)              | 3:1                   | 4:1     | Brown     | .023         | (74)              | 24:1                  | 64:1    |
| Beige  | .070         | (50)              | 4:1                   | 8:1     | Yellow    | .020         | (76)              | 32:1                  | 90:1    |
| Red  | .052         | (55)              | 5:1                   | 14:1    | Aqua      | .018         | (77)              | 38:1                  | 128:1   |
| White  | .043         | (57)              | 7:1                   | 20:1    | Purple    | .014         | (79)              | 64:1                  | 180:1   |
| Blue   | .040         | (60)              | 8:1                   | 24:1    | Pink      | .010         | (87)              | 128:1                 | 350:1   |
| Tan  | .035         | (65)              | 10:1                  | 30:1    |           |              |                   |                       |         |

**Troubleshooting Chart:**

| Problem                           | Cause  | Solution   |
|-----------------------------------|--|--|
| 1. Unit doesn't dispense          | <ul style="list-style-type: none"> <li>a. No water</li> <li>b. Magnetic valve not functioning</li> <li>c. Excessive water pressure</li> <li>d. Eductor clogged</li> <li>e. Low flow mechanism failure</li> <li>f. Clogged water inlet strainer</li> </ul>  | <ul style="list-style-type: none"> <li>a. Open water supply</li> <li>b. Install valve parts kit</li> <li>c. Install regulator if flowing water pressure exceeds 60 PSI</li> <li>d. Clean (descale) or replace</li> <li>e. Install new parts</li> <li>f. Disconnect inlet water line and clean strainer</li> </ul>  |
| 2. No concentrate draw            | <ul style="list-style-type: none"> <li>a. Clogged foot strainer</li> <li>b. Metering tip or eductor has scale build-up</li> <li>c. Low water pressure</li> <li>d. Discharge tube not in place (high flow only)</li> <li>e. Concentrate container empty</li> <li>f. Clogged water inlet strainer</li> <li>g. Selector out of position</li> <li>h. Check valve installed backwards</li> <li>i. Air leak in chemical pick-up tube</li> <li>j. Clear plastic tip installed in inlet hose barb</li> </ul> | <ul style="list-style-type: none"> <li>a. Clean or replace</li> <li>b. Clean (descale) or replace</li> <li>c. Minimum 25 PSI (with water running) required to operate unit properly</li> <li>d. Push tube firmly onto eductor discharge hose barb</li> <li>e. Replace with full container</li> <li>f. Disconnect inlet water line and clean strainer</li> <li>g. Assure selector is in position desired</li> <li>h. Confirm arrow on side of check valve is pointed toward eductor</li> <li>i. Put clamp on tube or replace tube if brittle</li> <li>j. Replace with colored metering tip</li> </ul> |
| 3. Excess concentrate draw        | <ul style="list-style-type: none"> <li>a. Metering tip not in place</li> </ul>   | <ul style="list-style-type: none"> <li>a. Press correct tip firmly into barb on product inlet</li> </ul>   |
| 4. Failure of unit to turn off    | <ul style="list-style-type: none"> <li>a. Water valve parts dirty or defective</li> <li>b. Magnet doesn't fully return</li> <li>c. Excessive water pressure</li> <li>d. Mechanism hangs up</li> </ul>  | <ul style="list-style-type: none"> <li>a. Clean or replace with valve parts kit</li> <li>b. Make sure magnet moves freely<br/>Replace spring if short or weak</li> <li>c. Install regulator if pressure (with water flowing) exceeds 60 PSI</li> <li>d. Be sure bracket is free to move and not broken</li> </ul>  |
| 5. Excess foaming in discharge    | <ul style="list-style-type: none"> <li>a. Air leak in chemical pick-up tube</li> <li>b. Unused concentrate inlet barb not plugged</li> </ul>   | <ul style="list-style-type: none"> <li>a. Put clamp on tube or replace tube if brittle</li> <li>b. Insert clear metering tip in unused concentrate inlet barb</li> </ul>   |
| 6. Solution comes out wrong tube. | <ul style="list-style-type: none"> <li>a. Incorrect tubes connected to inlet ports.</li> </ul>   | <ul style="list-style-type: none"> <li>a. Review instructions on matching products with proper inlet stubs</li> </ul>  |